

1

Thank you for purchasing the **Lynx-301** wireless-N network adapter from Nexxt Solutions. This quick installation guide will lead you through the basic setup process of the device to ensure its fast and seamless integration into your network.

Package content

- Wireless-N mini USB adapter
- [Quick installation guide](#)
- CD ROM (with a digital copy of the quick installation guide and driver configuration tool)

2

Initial setup

1. Insert the wireless USB adapter into an available USB port on your computer.



3

2. If the **Found New Hardware Wizard** system dialogue appears, select **Cancel** and use the included Setup Wizard Software CD for a faster installation.

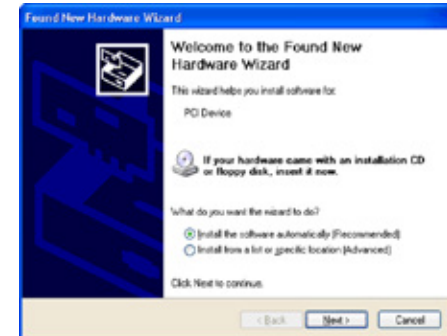

4

3. Insert the supplied software CD into the CD drive of your computer. Click on the Run button to continue. (If the autorun fails, double click **Setup.exe** in the software CD to manually install the software).

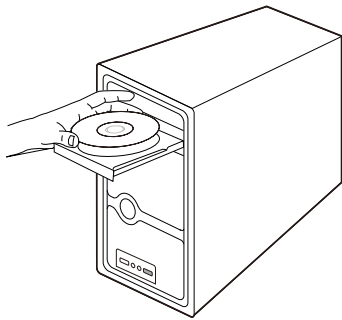

5

4. The following screen will be displayed in this step.



6

5. Click on **Install Now** to initiate the setup. The status bar appears on the screen during this process.

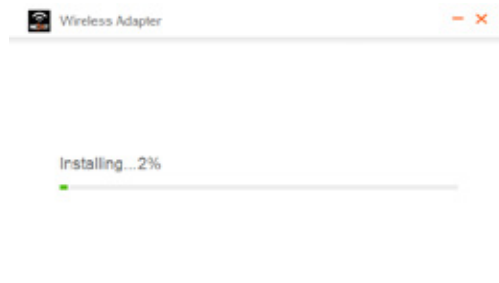

6. Once the progress bar reaches 100%, it means that the installation is complete.

7

Wireless network connection in Windows

1. The Lynx301 wireless adapter software will now be displayed.

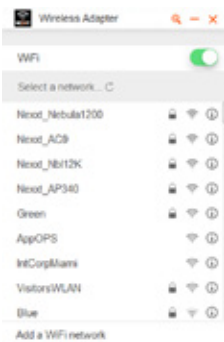

8

2. To connect to a wireless network, select the corresponding SSID from the list. If the wireless network you are connecting to is secured, you will be prompted to enter a password.

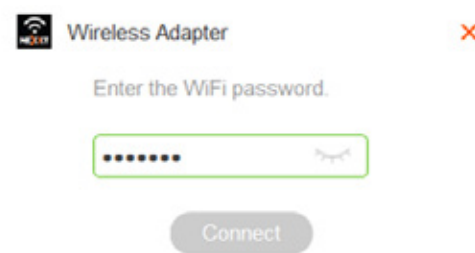

9

3. To view the password you have entered, you may click on the closed eye icon. The eye will open and will display the password you just typed in.

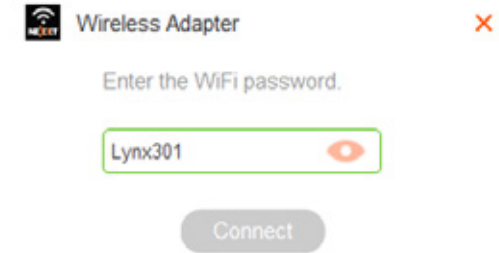

10

4. Once done, click on **Connect**. If the connection has been established successfully, a check mark next to the wireless router will be shown on the screen.



11

5. The WPS function can be used to securely connect to your wireless network. If your router supports this feature, click on the WPS button on the upper right hand corner of the Lynx301 wireless adapter software.

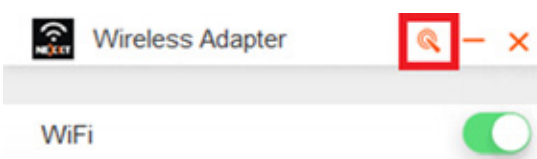

12

6. Click the **Connect** button. Within 2 minutes, press the WPS button on your wireless router.

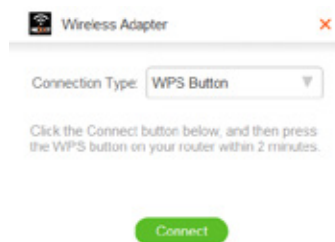

13

7. The Lynx301 Wireless Adapter can be disabled anytime. To do so, just click the green WiFi button. Simply click it once again to turn the wireless adapter back on.



14

FCC statement

This equipment has been tested and found to comply with the limits for a Class B digital device, pursuant to part 15 of the FCC rules. These limits are designed to provide reasonable protection against harmful interference in a residential installation. This equipment generates, uses and can radiate radio frequency energy and, if not installed and used in accordance with the instructions, may cause harmful interference to radio communications. However, there is no guarantee that interference will not occur in a particular installation. If this equipment does cause harmful interference to radio or television reception, which can be determined by turning the equipment off and on, the user is encouraged to try to correct the interference by one or more of the following measures:

15

- Reorient or relocate the receiving antenna.
- Increase the separation between the equipment and receiver.
- Connect the equipment into an outlet on a circuit different from that to which the receiver is connected.
- Consult the dealer or an experienced radio/TV technician for help.

FCC ID: X4YLN301